

POSB09100A series

9V / 1A Wall mounted type AC/DC adaptor



■ Features:

- Universal AC input / Full range
- ErP step II / CEC level VI compliance
- No load power consumption $P < 0.075W$
- Protections: Overload / Short circuit / Over Voltage



ELECTRICAL SPECIFICATION

MODEL	POSB 09100A
-------	-------------

OUTPUT

Rated Voltage	9V
Rated Current	1A
Current Range	0 ÷ 1A
Rated Power	9W
Line Regulation	± 1%
Load Regulation	± 5%
Tolerance	± 8%
Ripple & Noise (max.)	120mV _{p-p}
Setup, Rise Time	5000ms, 30ms / 230VAC at full load
Hold up Time (typ.)	4ms / 230VAC at full load

INPUT

Voltage Range	90 ÷ 264VAC
Frequency Range	47 ÷ 63Hz
Efficiency (typ.)	80.36%
AC Current (typ.)	0.3A / 230VAC
No load Power Consumption (max.)	0.075W

PROTECTIONS

Overload	Range: 105-200% Auto-recovery.
Short Circuit	Type: hiccup mode, auto-recovery.
Over Voltage	Type: auto-recovery.

POSB09100A series

9V / 1A Wall mounted type AC/DC adaptor



WORKING ENVIRONMENT

Working Temperature	0°C ÷ 45°C
Working Humidity	5 ÷ 90% RH non-condensing
Storage Temperature and Humidity	-20°C ÷ 85°C, 5 ÷ 90% RH non-condensing

SAFETY and EMC REGULATIONS

Safety Standards	Compliance to EN 62386
Withstand Voltage	IN/OUT: 3.6kVAC
Isolation Resistance	IN/OUT: 50MΩ/500VDC/25°C/70%
EMC Emission	Compliance to EN55032
EMC Immunity	Compliance to EN61000-4-2, -3, -4, -5
Harmonic Current	Compliance to EN61000-3-3; EN61000-3-2

OTHERS

DC wire and plug	Wire: 24AWG*2C, length = 1200mm	Plug: 2.1/5.5, positive inside
Net Weight / Dimensions	80.4g / 67 x 38 x 74mm (L x W x H)	

MECHANICAL SPECIFICATION

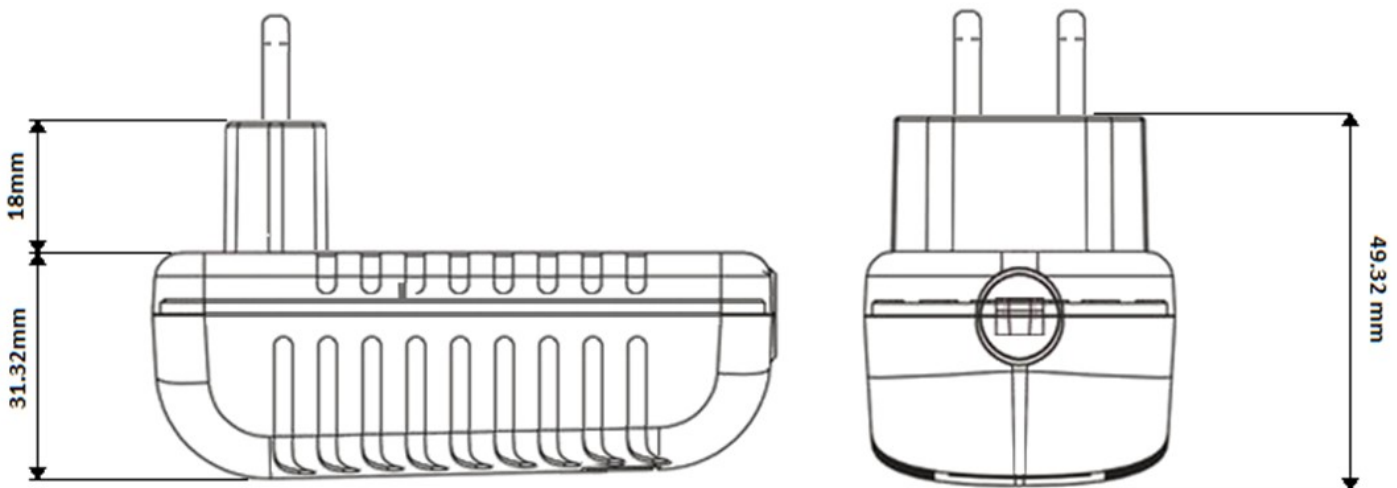

POSB09100A series

9V / 1A Wall mounted type AC/DC adaptor



MECHANICAL SPECIFICATION: DC wire and plug

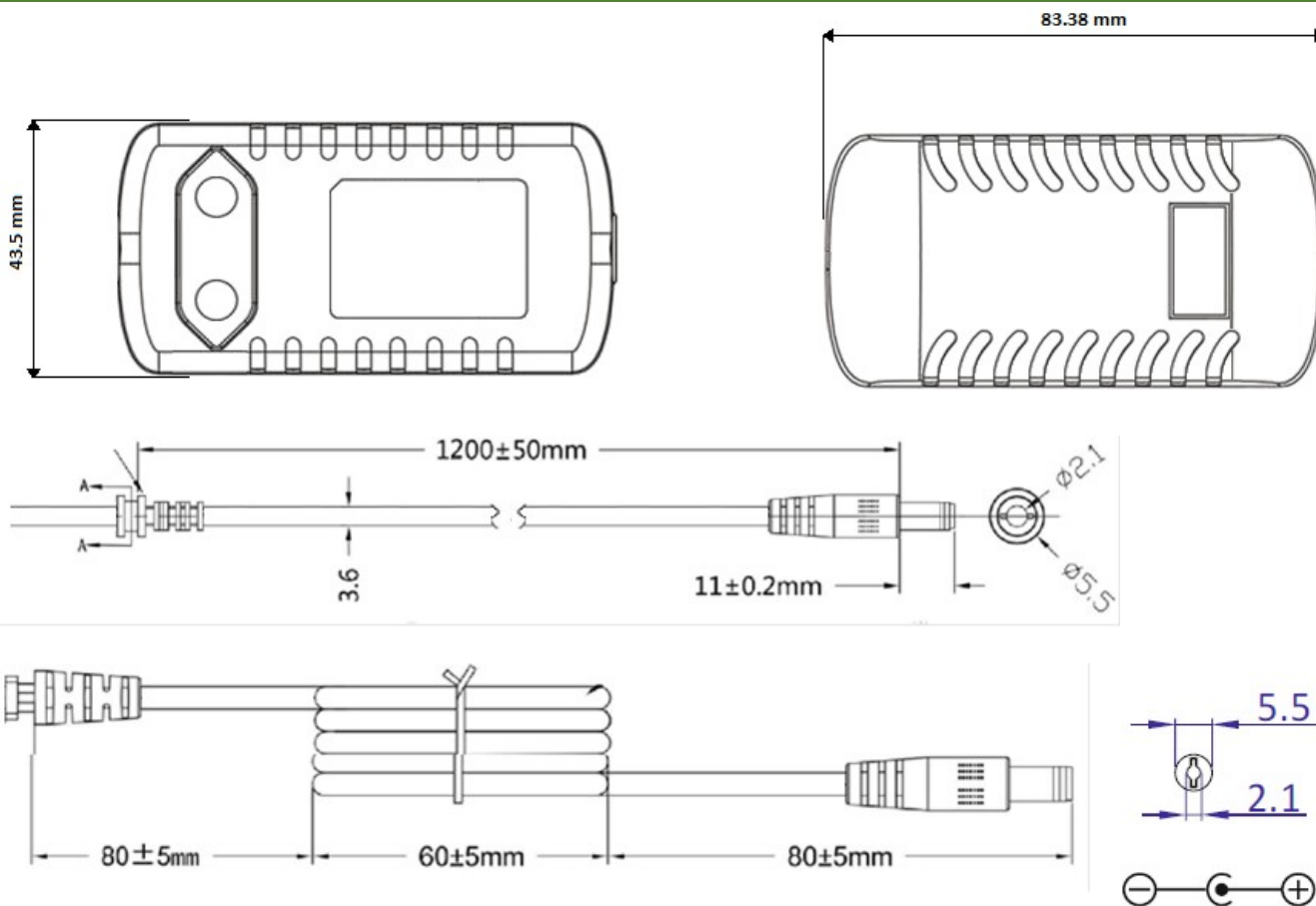

*MODEL	DC PLUG	X [mm]	Y [mm]	Polarity
POSB09100A	5.5x2.1mm	5.5	2.1	center positive
POSB09100A-25	5.5x2.5mm	5.5	2.5	center positive
POSB09100A-13	3.5x1.3mm	3.5	1.3	center positive
POSB09100A-40	4.0x1.7mm	4.0	1.7	center positive
POSB09100A-48	4.8x1.7mm	4.8	1.7	center positive
POSB09100A-CN	5.5x2.1mm	5.5	2.1	center negative
POSB09100A-25-CN	5.5x2.5mm	5.5	2.5	center negative
POSB09100A-13-CN	3.5x1.3mm	3.5	1.3	center negative
POSB09100A-40-CN	4.0x1.7mm	4.0	1.7	center negative
POSB09100A-48-CN	4.8x1.7mm	4.8	1.7	center negative

1. All parameters NOT specially mentioned are measured at 230VAC input, rated load and 25°C of ambient temperature.
2. Ripple & noise are measured at 20MHz of bandwidth by using a 12" twisted pair-wire terminated with a 0.1µF / 47µF parallel capacitor.
3. Tolerance includes set up tolerance, line regulation and load regulation.
4. Setup and rise time is measured from 0 to 90% rated output voltage.
5. Power supply is considered as component not indented to apply by end-user. Power supply meets safety and EMC standards however the final equipment with power supply must be re-quality to comply with EMC Directives.